



Nível de dificuldade



Quantidade de pessoas

Recursos necessários:

Chave philips ou parafusadeira, chave de fenda, trena, alicate, lápis e esquadro.

Orientações gerais:

A capacidade de carga de cada bandeja é de 10Kg. Todas as medidas deste produto são em milímetros.

Itens fornecidos:

A. Bandeja metálica menor*



A1. Cesto aramado menor**



B. Montante coluna maior



C. Bandeja metálica maior*

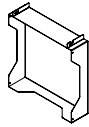

C1. Cesto aramado maior**



D. Chapa U 70x50x55mm



E. Corrediça telescópica 350mm

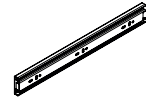

F. Paraf. CH FC M4x8mm



G. Porca MA-4 CH 7



H. Montante extensor coluna

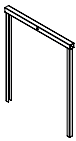

I. Paraf. Tellep SX Int. M6x20mm OT



J. Chave Tellep M-3



K. Montante fixação porta



L. Montante união inferior

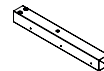

M. Montante união superior



N. Paraf. 1/4"x2" Lentilha



O. Paraf. Aço G10 MQ CIL. SXT. INT. NC3/16"x24mmx5/8" OT



P. Paraf. AAC. PN FC 4,2x16mm



Q. Terminal INT. 40x40mm



R. Terminal INT. 20x20mm



S. Paraf. PN FC M3,5x14mm



T. Paraf. PN 4,0x30mm



U. Chapa articulação



V. Montante articulação



W. Porca SEXT. Aut-trava 3/16"



X. Paraf. CH FC 3/16"x5/8"



Y. Arruela 3/16"x1/2"



Z. Paraf. MQ FS 3/16"x1" REDONDA



Z1. Paraf. PN FC 3,5x16mm



Z2. Arruela plástica



Z3. Suporte direito e esquerdo**



* Acompanha coluna alta com bandejas metálicas
** Acompanha coluna alta com cesto aramado

1. Desmonte a corrediça baixando o engate como mostra o detalhe abaixo:

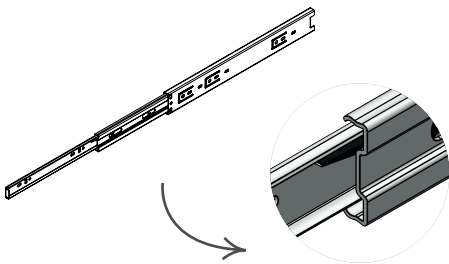

2. Fixe a chapa externa da corrediça (E) na chapa U (D) utilizando as ferragens (F) e (G).

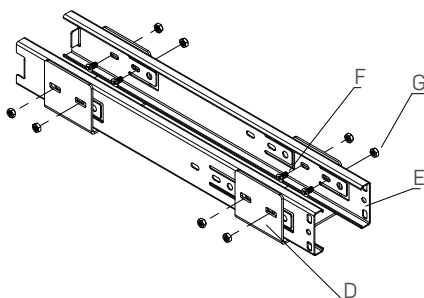

3. Fixe a parte interna da corrediça no montante de união inferior (L) e superior (M), usando a ferragem (P) conforme imagens abaixo:

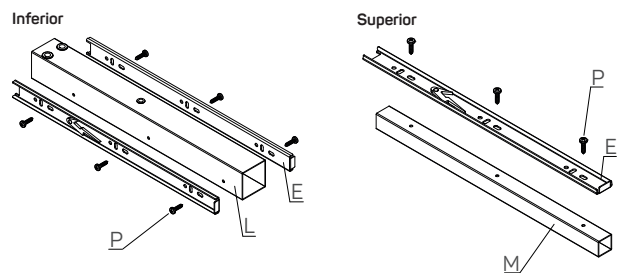

4. Faça a fixação dos montantes de união (L) e (M) no montante coluna maior (B) usando a ferragem (N).

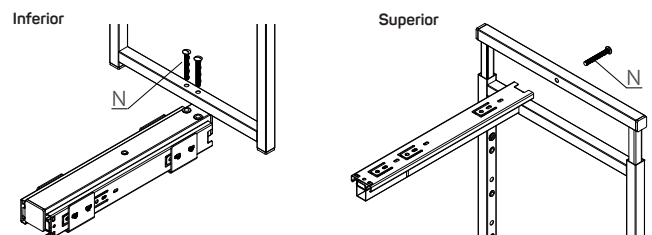

5. Realizar a montagem dos terminais (Q) e (R) conforme desenho abaixo:

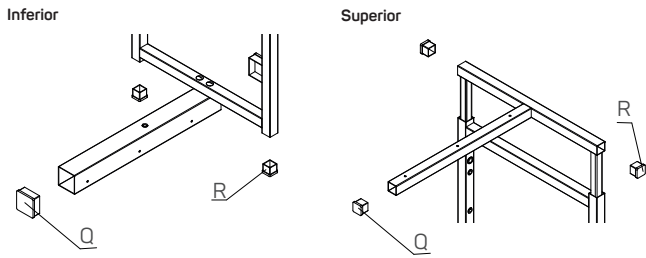

6. Monte os carrinhos dentro do móvel conforme as marcações sinalizadas na imagem abaixo:

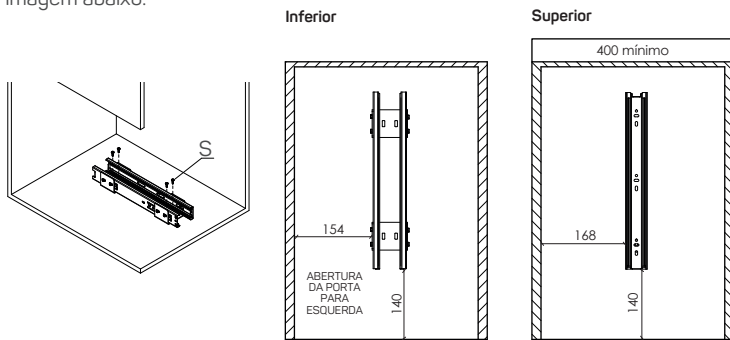

7. Introduza a estrutura no módulo encaixando as corredeiras.

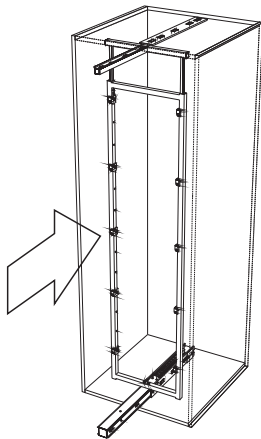

8. Para fazer o ajuste de altura do montante extensor (H), coloque o parafuso tellep (I) no montante conforme indicado na imagem, use a chave (J) e faça o aperto total depois de montada no móvel.

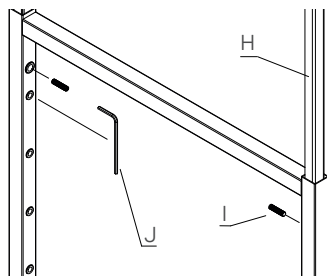

9. Montar a chapa articulação (U) com o montante articulação (V) utilizando toda a ferragem indicada na imagem.

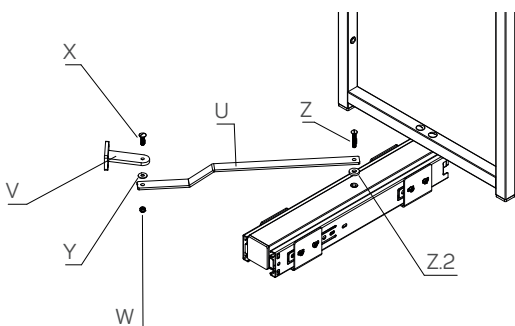

10. Posicione o montante (K) na porta conforme cotas que estão na imagem, usar a ferragem (T) para prender. **Obs:** a medida de Z é o valor que a porta sobrepõe o móvel.

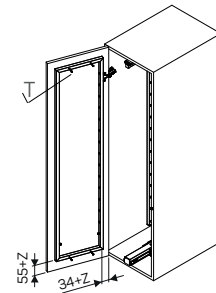

11. Para a montagem das bandejas metálicas (C), rosquear o parafuso (O) no montante, após isso encaixe a bandeja nos parafusos. A regulagem de altura entre as bandejas é de acordo com a necessidade do cliente.

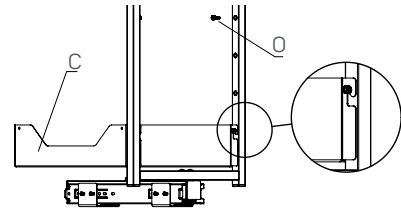

11.1. Para a montagem de cesto aramado, prenda o suporte (Z.3) com o parafuso (O).

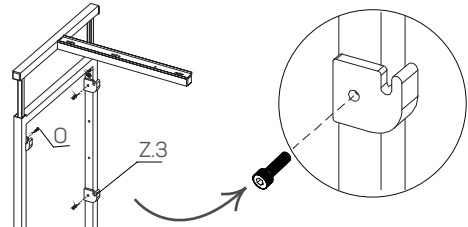

11.2. Encaixe o cesto no suporte de forma que o cesto maior fique com os dois pilares soldados na parte de trás da peça e o cesto menor fique com o lado da emenda do arame voltado para dentro do módulo.

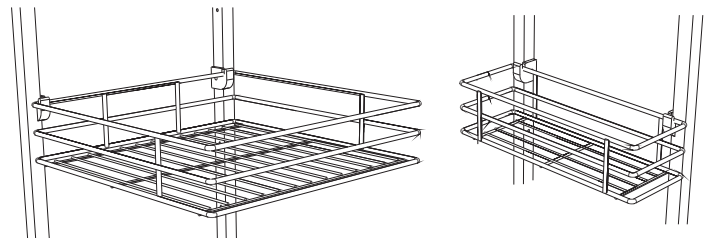

12. Faça as marcações do posicionamento da articulação na porta conforme medidas informadas. **Obs:** a medida de Z é o valor que a porta sobrepõe o móvel.

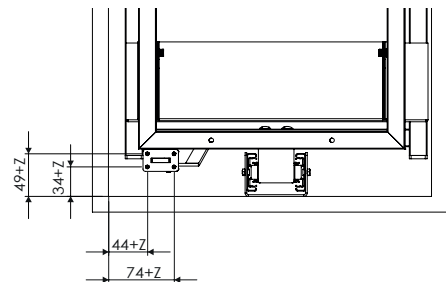

13. Fixe a articulação inferior e superior na porta com a ferragem (Z.1).

